

SIRIO 500 BANCO

Manuale di installazione, uso e manutenzione
Manual for installation, use and maintenance
Manual de instalación, uso y mantención
Notice d'installation, d'utilisation et d'entretien
INSTALLATIONS-, BEDIENUNGS- UND INSTANDHALTUNGSHANDBUCH



PLATONSERVICE

8 (800) 500-34-47

www.platonservice.com

Index General

Chapter 1 General information	1
1.1 Documentation supplied.....	1
Other documentation.....	1
1.2 This manual.....	1
Details about manual	1
Addressees	1
1.3 Information property rights	1
1.4 Conventions	2
Linguistic conventions	2
Printing conventions.....	2
1.5 Manufacturer identification details.....	3
1.6 Machine identification details	3
1.7 EC declaration of conformity.....	3
1.8 Guarantee	4
General conditions	4
Claiming under guarantee.....	5
Requests for spare parts.....	5
1.9 Use of the manual.....	5
1.10 Description of the machine	6
Intended use	6
Improper use	6
Machine structure.....	6
1.11 Qualifications of personnel.....	8
1.12 Safeguards.....	9
Fixed and moveable guards.....	9
.....	9
Passive safety devices.....	9
Active safety devices.....	10
Safeguarding.....	11
1.13 Hazardous areas and residual risks.....	11
Chapter 2 Machine Specifications	12
2.1 Technical specifications	12
Dimensions and weight of the machine	12
Other technical characteristics	12
Power Supply Details	12
Liability	13
Other Technical Details.....	14
Scraper.....	14
Chapter 3 Operator Interface	15

3.1 Controls	15
Controls	15
Chapter 4 Installation.....	16
4.1 Hazardous areas and residual risks during installation	16
4.2 Qualifications of operator.....	16
4.3 Transport	17
Transport conditions	17
Lifting	17
4.4 Preliminary operations	19
Check if the machine has been damaged during transport	19
Cleaning the machine	19
4.5 Installation.....	20
Features of the installation site	20
Acceptable environmental conditions for the installation site:	20
4.6 Preparation for start-up.....	20
Connections.....	20
4.7 Electric system.....	21
4.8 Testing	21
Chapter 5 Machine operation	22
5.1 Qualifications of operator.....	22
5.2 Work station.....	22
5.3 Operating modes	23
5.4 Machine switching on	23
5.5 Tooling, adjustments and setting up	23
Adjustment warnings	23
5.6 Starting	23
5.7 Routine stopping of machine	23
5.8 Emergency stop.....	23
5.9 Starting the machine again after a manual emergency stop	24
5.10 Switching off the machine.....	24
Chapter 6 Maintenance	25
6.1 Routine maintenance	25
Qualifications of operator.....	25
Pulizia	25
Suitable cleaning tools and products	26
6.2 Scheduled servicing.....	27
Qualifications of operator.....	27
Regular inspections	27
Chapter 7 Machine scrapping	28
7.1 Qualifications of operator.....	28
7.2 Disconnecting the machine.....	28
7.3 Disconnection procedure	28
7.4 Residual risks after machine disconnection.....	29
Chapter 8 List of attached documentation	30

Chapter 1 General information.

1.1 Documentation supplied

- Instruction manual (this booklet)
- Spare parts catalogue.

Other documentation

- Wiring diagrams

1.2 This manual

Details about manual

Instruction manual:

Model:

- Edition:
- Year and month of printing:

Addressees

- Carrier.
- Installer.
- End user.
- Maintenance engineer.

1.3 Information property rights

This manual contains copyright information. All rights are reserved.

No part of this manual can be reproduced or photocopied without the prior written permission of the manufacturer. Permission to use this documentation has only be given to the customer to whom the manual has been supplied as part of the machine's equipment and only for the purpose of installation, operation and maintenance of the machine to which the manual refers.

The manufacturer declares that all the information contained herein is in accordance with the technical and safety specifications of the machine to which the manual refers. The manufacturer will not be held responsible for direct or indirect damage or injury to persons, objects or animals resulting from the use of this documentation or the machine in non-standard conditions.

The manufacturer reserves the right to introduce technical modifications or improvements both to the documentation and to the machines without prior notice. Modifications and improvements may also concern other machines of the same model described in this manual, but which have a different serial number. The information contained herein refers in particular to the machine specified in 1.6 "Machine identification details" on page 3.

1.4 Conventions

Linguistic conventions

- On the left, on the right : when speaking of such, we refer to the operator's position when facing the control panel.
- Qualified workers : all those persons who thanks to their training, experience, education as well as their knowledge of standards, regulations, safety precautions and operation conditions, have been authorised by the person in charge of plant safety to carry out any necessary action and are capable of identifying and avoiding possible danger.

Printing conventions

Text in italics : this indicates the title of a chapter, a section, a subsection, a paragraph, a table or a drawing in this manual or other reference document.

PSE : Personal Safety Equipment.

(N) where N represents a generic number (e.g. **(3)**): symbolic representation of a control or warning device (e.g. buttons, selectors and indicator lights).

(L) where L represents a generic letter (e.g. **(B)**): symbolic representation of a part of the machine.

NOTE Notes contain important information and are highlighted separately from the text to which they refer.

BEWARE Beware indications describe the procedures the partial or total non-observance of which can cause damage to the machine or to devices connected to it.

DANGER Danger indications describe the procedures the partial or total non-observance of which can injure or harm the operator's health.

1.5 Manufacturer identification details

1.6 Machine identification details

Type:

Model:

Serial no.:

Year of manufacture: _____

1.7 EC declaration of conformity

See Enclosure 1 EC declaration of conformity.



PLATON SERVICE
8 (800) 500-34-41
www.platonservice.com

1.8 Guarantee

General conditions

1. This machine (with appropriate serial number) is guaranteed for 12 months after the date of actual delivery.
This guarantee is, however, subject to the claim being made by means of registered letter, within 8 days after discovery of any faults or defects providing that prior confirmation and acknowledgement is obtained from the manufacturer.
2. The guarantee covers the replacement or repair of the faulty part (component, machine or part of the machine) but does not cover the cost of dismantlement, re-assembly or shipping.
3. The replacement of any part does not bring about the renewal of the guarantee period for the entire machine, unless the entire machine is replaced.
Therefore, in no circumstances shall the manufacturer be liable for compensation of whatever type and the purchaser shall relinquish any claim for damage, loss or expense, even to third parties, arising from machine stoppage.
4. This guarantee does not cover the electrical parts and the parts subject to normal wear and tear or deterioration due to external atmospheric or environmental agents nor does it cover any defects arising from the failure to carry out maintenance or insufficient or incorrect maintenance, nor does it cover use by unqualified personnel, misuse, abuse or improper use, unauthorised alterations or repairs or tampering of any kind.
5. The validity of the guarantee is subject to the performance of correct maintenance as described in *Chapter 6 Maintenance* of the instruction manual supplied with the machine.
6. The guarantee is not valid if payment conditions have not been observed.
7. As far as parts supplied by other manufacturers are concerned, said parts are guaranteed in accordance with the terms of the said manufacturer's warranty.
8. Any controversy shall be governed directly by the court of Competent Jurisdiction.

NOTE

In the event of repairs performed at the place of machine installation, the machine guarantee certificate must be presented to the service engineer and the guarantee is valid only if fully completed.

Special guarantee conditions will be explicitly stated in the sales contract.

The guarantee will expire in the following cases:

- Improper machine use (see *Improper use* on page 6).
- Use of equipment different from the equipment specified in *Chapter 6 Maintenance*.
- Assembly of the machine in conditions different from those specified in *Chapter 4 Installation*.
- Connections which fail to comply with the specifications given in *Chapter 4 Installation*.
- Use of non-original spare parts or parts not specified by the manufacturer.

Claiming under guarantee

Method

Requests for spare parts or service visits under guarantee must be made to the manufacturer or to your authorised dealer as soon as possible after having encountered the defect which is covered by the *General conditions* on page 4.

BEWARE We recommend the use of original spare parts.

Always state the type, model and serial number of the machine when requesting spare parts under guarantee. This information can be found on the name plate of the machine.

NOTE Failure to comply with the instructions contained herein will release the manufacturer from any liability in the event of accidents to persons and/or objects, or machine malfunctioning.

Requests for spare parts

When requesting spare parts please state the following information:

- Type of machine.
- No. of production order marked on the relevant label.
- Year of manufacture.
- Reference number of the required part which can be found on attachments spare parts given in the spare parts catalogue.

If necessary please contact:

1.9 Use of the manual

Read the following chapters carefully: *Chapter 1 General information.*, *Fig. 1.1 Overall view of machine*, *Chapter 2 Machine Specifications*, *Chapter 3 Operator Interface*.

Consult the relevant chapter before attempting installation, operation, maintenance or dismantlement.

NOTE This manual should be kept in good condition for the whole of the life of the machine and should be stored where it can be easily found when required. The manual should be handed over to the purchaser of the machine if this is sold to someone else.

1.10 Description of the machine

Intended use

Intended operations

The machine has been built and designed to sheet dough to the thickness required by the operator.

Conditions of intended use

The machine has been designed and built to operate in a closed environment, protected from atmospheric agents.

Intended use of power

The machine is driven by electric energy, which is converted into mechanical energy for the intended operations.

Improper use

Improper use means any operation not expressly stated in the *Intended use* on page 6, in particular:

- Operating the machine in an explosive environment.
- Operating the machine in a flammable environment.
- Washing the machine control area with jets of water.

Machine structure

This section describes the main machine components and their function within the production cycle.

Main machine components

The machine is composed of the following principal components:

1. Base
2. Control Panel
3. Conveyor Belts
4. Sheeting cylinders
5. Scrapers
6. Handle for selecting pastry thickness
7. Pastry tray

Fig. 1.1 Overall view of machine

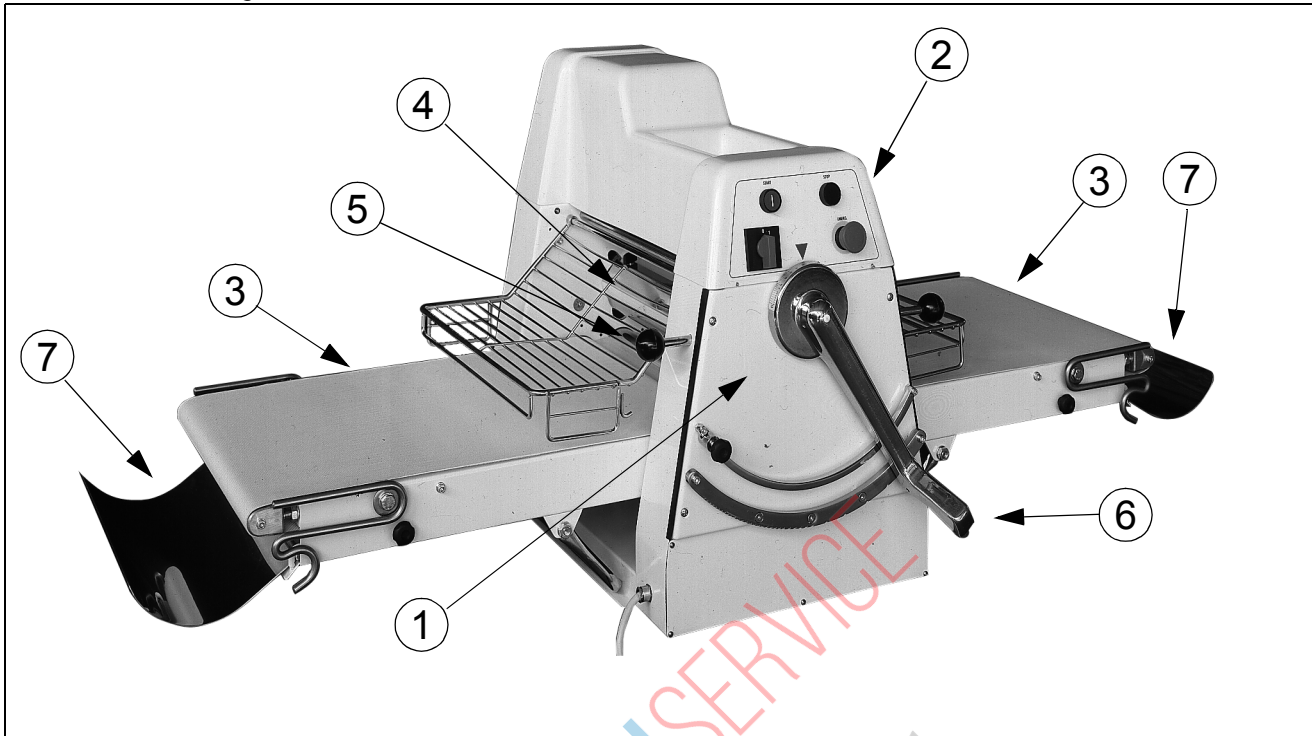

During the design and construction of this machine the manufacturer has adopted the criteria and devices needed to satisfy the essential safety requirements imposed by the Machinery Safety Directive 98/37/CE and subsequent amendments, by the Low Voltage Directive 73/23/EEC and subsequent amendments and by the Electromagnetic Compatibility Directive 89/336/EEC and subsequent amendments.

The careful analysis of risks carried out by the manufacturer has eliminated most of the risks (predicted or reasonably predictable) linked to the machine operation conditions.

The complete documentation of safety measures taken is contained in the technical brochure of the machine kept at the manufacturer.

The manufacturer strongly recommends careful observation of the instructions, procedures and recommendations contained herein as well as strict observation of the current safety regulations regarding the work environment. This also applies to the use of both the correct personal safety equipment and machine protection devices.

DANGER Do not wear loose clothing, ties, chains, or watches that could get caught in the moving parts of the machine.

NOTE the manufacturer will not be liable for any damage or injury to persons, animals or things caused by non-observance of the safety rules and/or recommendations given in the documentation supplied.

1.11 Qualifications of personnel

Stage in the technical life of the machine	Qualification of operator in charge
Transport	Qualified carrier informed of: <i>Fig. 1.1 Overall view of machine,</i> <i>4.3 Transport on page 17 of this manual.</i>
Installation	Qualified electrician and qualified mechanic informed of : <i>Fig. 1.1 Overall view of machine,</i> <i>Chapter 2 Machine Specifications,</i> <i>Chapter 3 Operator Interface</i> <i>Chapter 4 Installation.</i>
Operation	Trained worker informed of : <i>Fig. 1.1 Overall view of machine,</i> <i>Chapter 2 Machine Specifications,</i> <i>Chapter 3 Operator Interface,</i> <i>Chapter 5 Machine operation.</i>
Maintenance	There are three different types of workers who can carry out interventions on the machine: <ul style="list-style-type: none"> • Mechanical maintenance engineer: qualified engineer able to operate the machine in normal conditions and with the machine guards open. Able to carry out adjustments, maintenance and repairs on mechanical parts. This worker should not be assigned to electrical interventions on live parts.. • Electrician: qualified engineer able to operate the machine in normal conditions and with the machine guards open. Able to carry out electrical adjustments, maintenance and repairs. This worker can be assigned to electrical interventions on live parts inside the electric control box. • Manufacture's engineer: qualified engineer put at customer's disposal by the manufacturer to carry out complicated repairing in special conditions, according to the agreements taken with the customer.
Scrapping	Qualified mechanic informed of: <i>Fig. 1.1 Overall view of machine,</i> <i>Chapter 7 Machine scrapping.</i>
NOTE	the manufacturer will not be liable for damage or injury to persons, animals or things resulting from the action of unqualified operators.



1.12 Safeguards

DEFINIZIONE

Safeguards are any safety measures which involve the application of specific technical mechanisms (guards, safety devices) to protect people from dangers which cannot be made sufficiently harmless through design.

Fixed and moveable guards

- All power transmission components are shielded by screw-fastened guards, in compliance (A), with the EN 953 standard.
- All moving parts are protected by the metal safety grille (B).

Fig. 1.2 Fixed and moveable guards

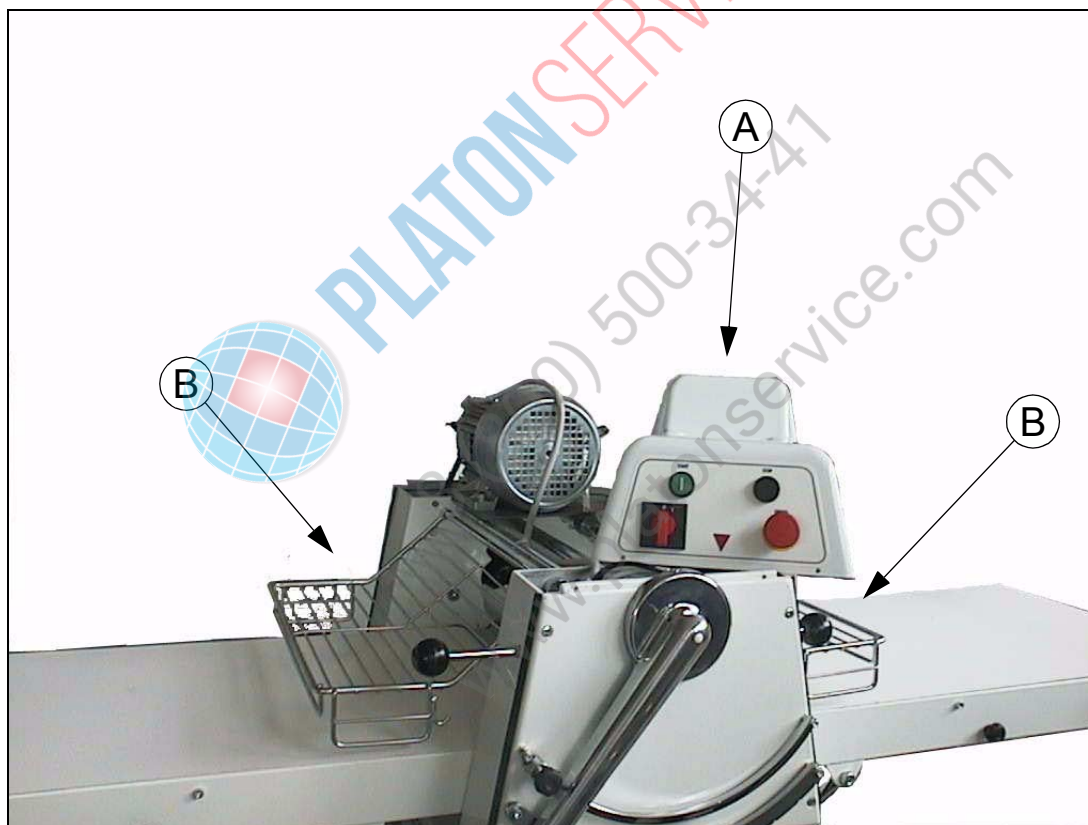

Passive safety devices

DEFINIZIONE

Passive safety devices are those devices or safeguarding techniques which eliminate or reduce potential hazards for the operator without the operator having to actively intervene.

Limit switch devices

The machine is equipped with two limit switch microswitches **(A)** and **(B)** (Fig. 1.3). These are energised by means of two cams **(C)** and **(D)**, D which are in turn fixed to the safety grille (Fig. 1.2 Fixed and moveable guards on page 9). If the operator raises the protection grille the cams turn and energise the relevant microswitch which controls a Machine Stoppage.

Two other microswitches are present in the machine **(E)** and **(F)**, these can be energised by two gauges which are fixed to a manual control bar. This type of stress means that the direction of the conveyor belts and cylinders is inverted.

Fig. 1.3 Microswitch

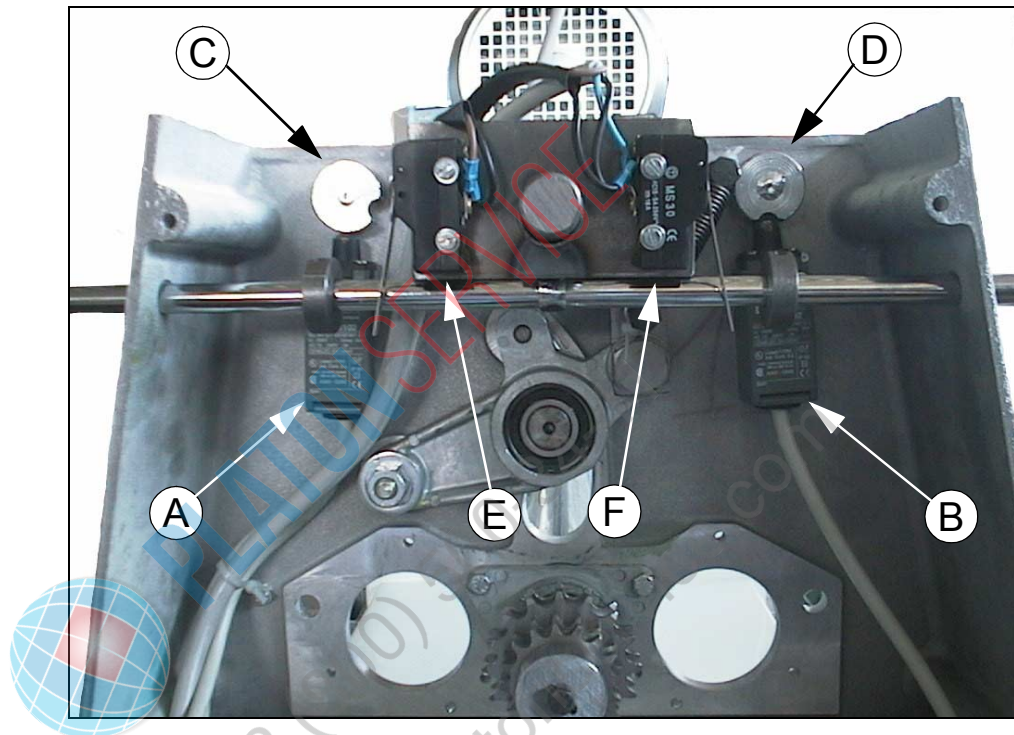

Active safety devices

DEFINIZIONE

Active safety devices are those devices or safeguarding techniques which eliminate or reduce potential hazards and which require active and conscious intervention by the operator in order to activate their accident preventative action..

Emergency stop

The emergency button is located on the main control panel of the machine and allows the operator to stop the machine in an emergency.

Fig. 1.4

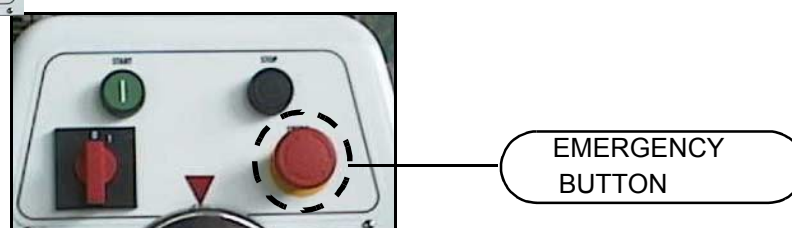

Safeguarding

- The electrical equipment offers protection against personal injury caused by electrical discharge due to direct and indirect contact in compliance with the CEI EN 60204-1 standard.
- All the electrical power parts and those with dangerous voltage are contained in the electrical box protected to IP54, in compliance with the CEI EN 60204-1 standard. The control and power supply voltages for all the accessible parts are 12 and 24V; moreover both these lines are protected against short-circuiting and accidental contact to earth.

DANGER Tampering with safety devices creates hazards for the machine operators and other exposed persons.

NOTE The manufacturer will not be liable for injury or damage to people, animals or things caused by tampering with the machine's safety devices.

1.13 Hazardous areas and residual risks

DEFINIZIONE

A hazardous area is any area inside or in the vicinity of the machine which would constitute a risk for the health and safety of an exposed person..

This manual indicates all the procedures during which residual risks for the operator are present. The residual risks can be eliminated by carefully following the procedures indicated in this manual and by using the recommended personal safety equipment.



Protective gloves must be worn.



Protective footwear must be worn.

Handling area of the packed or unpacked machine. The following risks are present here:

- Impact hazard for operator.
- Crushing hazard.

The following PSE must be used by the operator:



- Protective footwear.
- Protective gloves..

DANGER the manufacturer will not be liable for damage or injury to persons, animals or things resulting from non-compliance with the safety rules or from the recommended PSE not being worn.

Chapter 2 Machine Specifications

2.1 Technical specifications

Dimensions and weight of the machine

Model	Working Dimensions mm	Closed Dimensions mm	Weight kg
500x710	1800x860x640	520x860x830	115
500x950	2320x860x640	520x860x1100	120

Other technical characteristics

Roller Lengths (mm).	500
Cylinder Diameter (mm)	60
Cylinder Range (mm)	From 0 to 35

Power Supply Details

Electrical Installation

Electrical Power

Tension	380 \pm 10% V three-phase
	230 \pm 10% V mono-phase
Frequency	50 \pm 1% Hz
Power of Electrical motor	1 Cv.

Tolerances of the electrical power supply

Voltage

Running voltage: \pm 10% of rated voltage.

Frequency

\pm 1% of rated frequency in continuous running

\pm 2% of rated frequency for a short working period.

Harmonics

The harmonic distortion, for the sum of harmonics from the second to the fifth, should not exceed 10% of the total voltage with effective value between live conductors. A further distortion of 2% for the sum of the harmonics from the sixth to the thirtieth on the total effective value between live conductors is tolerated.

Unbalance of the three-phase power supply voltage.

Neither the inverse sequence component, nor the zero sequence component should exceed 2% of the direct sequence component of the voltage.

Voltage pulses.

These must not last longer than 1.5 ms with a rise/descent time between 500 ns and 500 ms and a peak value not greater than 200% of the effective value of the rated power supply voltage.

Breaks in voltage.

The power supply should not be broken or the voltage must not drop to zero for more than 3 ms, regardless of the instant of the supply wave. More than 1 s should elapse between two consecutive breaks.

Voltage drops.

Voltage drops should not exceed 20% of the peak voltage of the power supply for more than 1 cycle. More than 1 s should elapse between two consecutive voltage drops.

Liability

NOTE	the manufacturer will not be liable for defects, breakdowns or malfunctioning arising from the non-compliance with the power supply values stated.
-------------	--



PLATON SERVICE
8 (800) 500-34-41
www.platonservice.com

Other Technical Details

Scraper.

In case of movement it is possible to reposition the scraper:

- remove the spring **(A)** from the fixing screw **(B)**
- unscrew the screw **(C)**
- adjust the scraper **(D)**
- tighten the screw **(C)**
- re hook the spring **(A)** to the screw **(B)**.

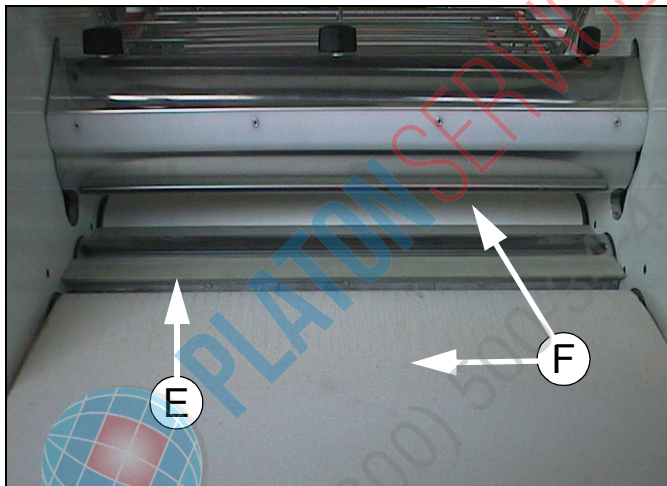
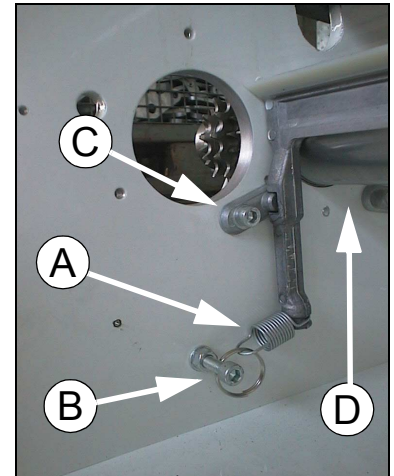

The scraper **(E)** facilitates the movement of the dough from one conveyor belt to the other **(F)**.

Chapter 3 Operator Interface

3.1 Controls

Controls

Symbol	Description	Functions controlled
①	Red mushroom button on a yellow background.	EMERGENCY button. When pressed, this stops the machine completely by cutting off the voltage to the electric circuits.
②	ON /OFF button	When On is pressed power is supplied to the machine's motor.
③	START Button.	When pressed, the motor begins to turn the belts.
④	STOP Button.	When pressed the motor stops, but is not disconnected from the power supply.
⑤	Manually operated handle to alter the direction of the belts.	When pushed it changes the direction of the conveyor belts and the movement of the sheeting cylinders.
⑥	Handle for dough thickness selection.	When turned it increases or reduces the distance between the sheeting cylinders.

Fig. 3.1 Controls

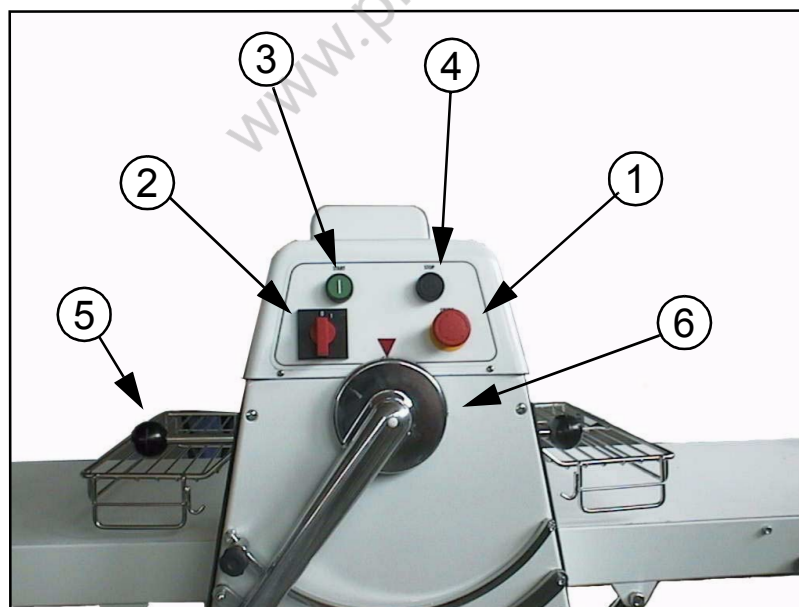

Chapter 4 Installation

NOTE When reading this chapter refer to the pictures of the control panels given in *Chapter 3 Operator Interface*.

4.1 Hazardous areas and residual risks during installation



Protective gloves must be worn.



Protective footwear must be worn.

Handling area of the packed or unpacked machine. The following risks are present here:

- Impact hazard for operator.
- Crushing hazard.

The following PSE must be used by the operator:



- Protective footwear.
- Protective gloves.

DANGER When unloading, hoisting and handling the machine, personnel must wear the appropriate PSE, such as gloves, boots, helmet and use the appropriate tools.

4.2 Qualifications of operator

The installation of the machine should only be carried out by trained, qualified and authorised personnel after having read and understood the information given in this manual.

4.3 Transport

The instructions given in this section should be carefully followed when transporting the machine. This operation may include the following situations:

- Storage of the machine.
- Initial installation of the machine.
- Re-location of the machine.

Transport conditions

The machine and its equipment can be transported in the following ways, according to the customer's requirements:

- **Carton on pallet**
- **Wooden crate**
- **Pallet**
- In each of these cases, before transport or handling, the various accessories must be packed and fastened to the machine.

NOTE Follow standard precautions to avoid collisions and tipping over..

Symbols on the machine packing

The following symbols are shown on the machine packing:

- Handle with care.
- Centre of gravity.
- Hooking point.
- Store in a dry place.
- This side up.
- CE marking.

Lifting

-
- DANGER**
- It is forbidden to climb onto the machine and/or its packing or stop and/or pass under the machine during handling.
 - Access to the lifting and handling area is denied to all personnel except those directly involved in the operations.
 - All operators should remain at a safe distance in order to avoid being hit by the machine or any of its parts which may accidentally fall.
 - Before starting the lifting operations the whole of the machine handling area, including the parking area for the means of transport and the machine installation area, should be identified and inspected in order to detect any potentially hazardous areas.
 - Use a bridge crane, a crane or a forklift truck with adequate lifting capacity. The use of inadequate lifting equipment may cause damage to the machine or injury to personnel.

- Check that the hoisting cables or ropes are equipped with bell and have the label which contains all the manufacturer's details and that the lifting capacity is clearly stated.
- Check the cables or ropes before each lifting operation. Do not use these if they are damaged or worn or have broken strands or wires.
- Never twist or knot ropes or cables. Always follow the instructions supplied by the manufacturer.
- Follow the same precautions when using chains or belts.

Lifting and handling the packed machine

Fig. 4.1 Lifting and handling the packed machine

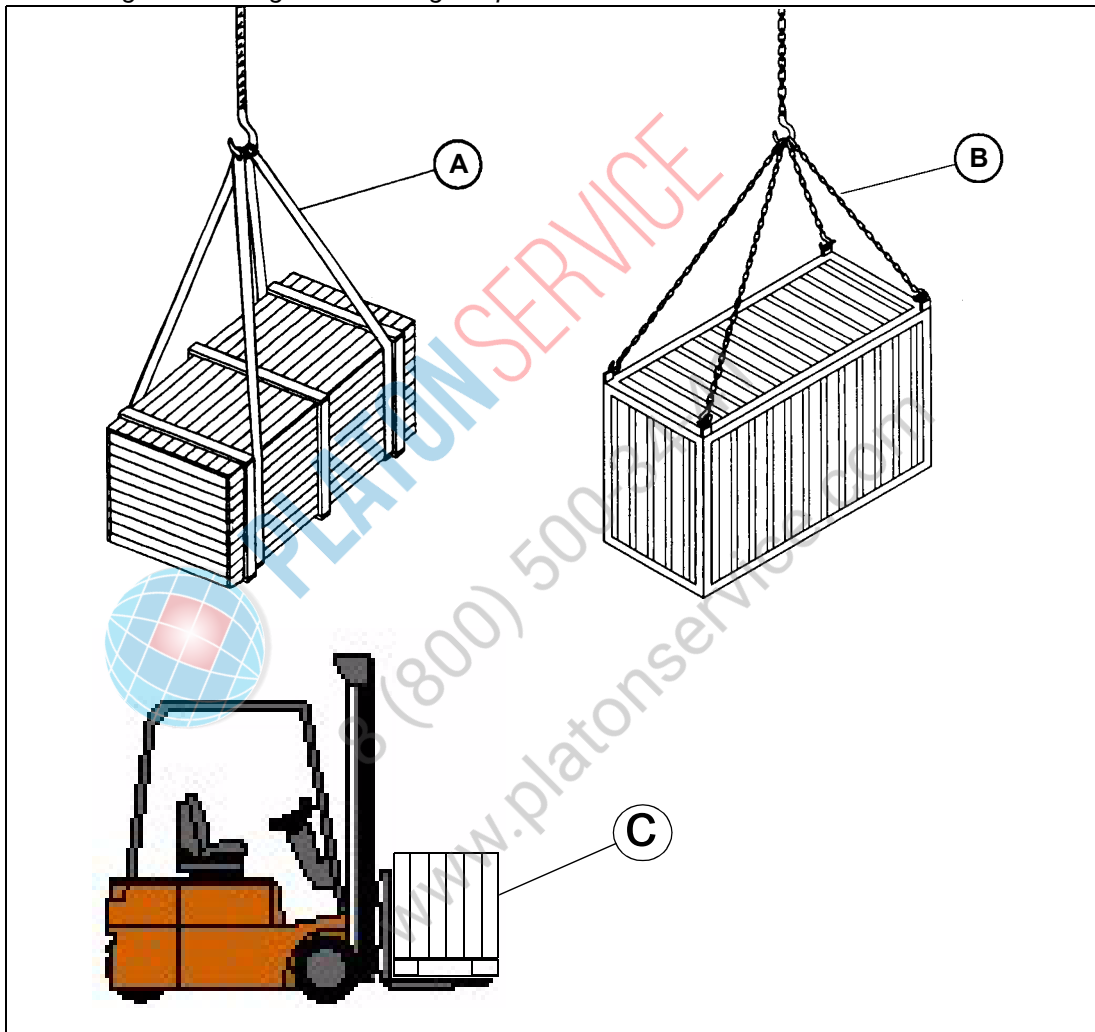

Wooden crate on the vehicle platform

The crate/container should be unloaded from the vehicle using a forklift truck (C) or using lifting equipment in the following way:

1. Insert the cables or ropes (A) under the box pallet and attach them to the hook of the crane/bridge crane. If the machine is packed in a container insert the hooks of the chains (B) into the appropriate brackets.
2. Lift the box pallet /container just enough to be able to unload it.
3. Position the box pallet /container in the planned position.

Wooden crate on the ground

The crate/container should be unloaded from the vehicle using a forklift truck (C) or using lifting equipment in the following way:

1. Insert the cables or ropes (A) under the box pallet and attach them to the hook of the crane/bridge crane. If the machine is packed in a container insert the hooks of the chains (B) into the appropriate brackets.
2. Lift the box pallet/container just enough to be able to handle it.
3. Position the box pallet/container in the planned position for unpacking.

Equipment for hoisting and handling the packed machine

- The following equipment is required to hoist the machine :
- Crane / bridge crane with adequate lifting capacity.
- Forklift truck with adequate lifting capacity.

BEWARE If the machine has been damaged during transport, inform the manufacturer immediately. The manufacturer should also be informed if there are differences between the "Packing list" and the goods actually delivered.

BEWARE The machine and its equipment should be protected from external atmospheric agents. In particular water and damp can cause certain machine components to rust, causing irreversible damage.

4.4 Preliminary operations

Check if the machine has been damaged during transport

Check the condition of the machine taking a close look at the outside and the inside. Any deformation of the visible parts indicates that the machine has been hit by something during transport. This could lead to malfunctioning.

Check the tightening of screws, bolts and fittings.

If damage has occurred:

Damage caused by transport should be attributed to the carrier and the manufacturer or its agent should be informed immediately of the situation.

Cleaning the machine

- Remove the dust and dirt deposited on the surface during transport.
- Carefully clean and dry each part (varnished or unvarnished) using soft, clean, dry cloths.

BEWARE It is strictly forbidden to climb onto the box pallets and/or to stow them one on top of the other.

- Should the box pallets remain outdoors for some time, waiting to be transported inside the building, these box pallets should be covered with adequately-sized waterproof tarpaulins.
- If storage exceeds 3 months the box pallets should be stored inside, sheltered from bad weather and protected from excessively high or low temperatures.
- If the machine is unpacked, it should be covered in order to prevent the build-up of dust and dirt.

4.5 Installation

Features of the installation site

A suitable installation site should be chosen considering the overall dimensions of the machine supplied in *2.1 Technical specifications* on page 12, and in compliance with the following rules:

- The power supply source, in compliance with the *Power Supply Details* on page 12, should be near the installation site.
- Nothing should hinder the free movement of the operator around the machine. The machine should be situated at least 1 metre from the nearest wall or object.
- Cabinets should be accessible at all times and the doors should open wide without obstacle.
- Make sure there is sufficient space for machine operation and maintenance and also for any other additional equipment.

Protection against external atmospheric agents

The machine should be installed in a covered building, shielded from direct contact with atmospheric agents.

Lighting

Adequate lighting is necessary to carry out both normal operation and servicing of the machine in a safe way. The machine has no built-in lighting system.

A well-lit environment prevents hazards due to areas in shadows.

Acceptable environmental conditions for the installation site:

- Temperature: from 5° C to 40 °C with the average temperature not exceeding 35°C over a period of 24 hours.
- Relative humidity: from 50% at a temperature of 40°C up to 90 % at a temperature of 20° C.

NOTE The temperatures limits have been established taking into account the electrical equipment of the machine.

4.6 Preparation for start-up

Connections

Electrical connections

The machine has only one connection to the mains electricity supply.

DANGER Make sure that the values of your mains electricity supply comply with the power specifications of the machine.

Electrical hazards. Make sure the machine is adequately earthed before making any other connection to the mains power supply.

4.7 Electric system

Fig. 4.2 Electric system position

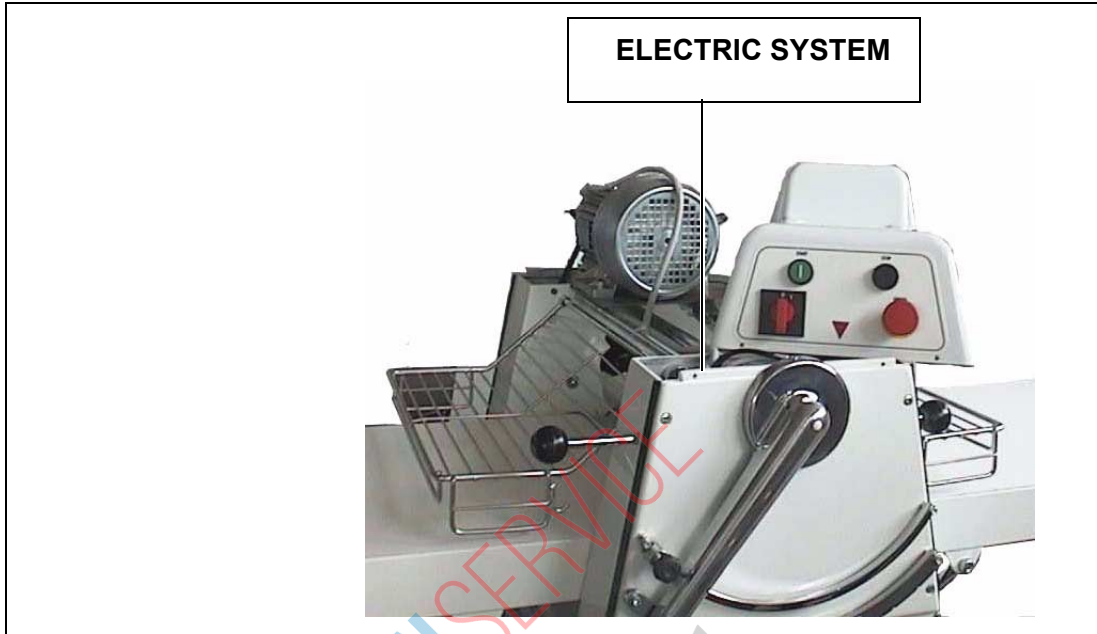

4.8 Testing

Before delivery the machine is tested at the manufacturer's works where the following operations are carried out:

- General setting of the machine, of the auxiliary equipment and of the installed safety devices.
- Running test to check all the adjustments carried out (correct rotation of motors, tightness of pneumatic systems, effectiveness of safety devices and of limit switches).
- Performance of test cycles under safe conditions.

Checking the safety devices

Before starting the machine, the safety devices should be checked according to the following procedure:

1. Correct operation of the emergency stop button **①** (Fig. 3.1 Controls on page 15) ; while the machine is operating, press the emergency buttons: the machine should stop immediately.

NOTE If the machine does not stop immediately, the emergency buttons must be checked and/or replaced.

1. Should a problem arise, when the machine is running, for which no instructions are given in this manual, please contact the Technical After Sales Service (see 1.5 Manufacturer identification details on page 3).

Chapter 5 Machine operation

NOTE When reading this chapter refer to the pictures of the control panels given in *Chapter 3 Operator Interface*.

5.1 Qualifications of operator

The machine should be operated only by trained, qualified and authorised personnel who have read and understood the information contained in this manual.

5.2 Work station

Work station on page 22 shows the working positions in which the operator can operate the machine safely.

The control station of the machine is located in front of the control panel. From this position the operator controls all the working parameters.

NOTE While the machine is running, access to the working area of the machine is strictly forbidden.

Work station

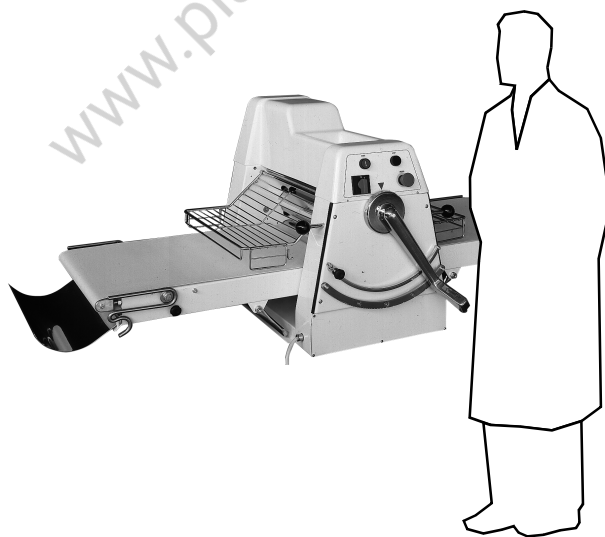

5.3 Operating modes

The machine operates in manual mode following the instructions given in 5.6 *Starting* on page 23

5.4 Machine switching on

To switch the machine on proceed as follows:

1. Turn the knife-switch situated upstream from the outside power supply cable to position I.

5.5 Tooling, adjustments and setting up

Adjustment warnings

1. All adjustment, checking or cleaning operations must be carried out with the machine at a standstill and the electric control box off. The main on-off switch must be set to position O and padlocked; the pneumatic shut-off valve must be closed. Any operation carried out while the wiring system is live can cause serious injuries.
2. Pay special attention to the moving parts of the machine.
3. Take special care when activating the start buttons and only activate these after making sure that persons or things are in no danger.
4. If the guards or safety barriers have been removed, make sure they are correctly re-installed before using the machine again.
5. Do not rest tools or other objects on the machine, either when operating or off.

5.6 Starting

For routine machine operation, proceed as follows:

1. Turn the main on-off switch (1) situated on the electric control box to position "I" .
2. Press button (2) and button (3) together (Fig. 3.1 Controls on page 15) .

5.7 Routine stopping of machine

Stopping procedure:

1. Make sure the work cycle is finished.
2. Turn the main on-off switch to position O.

5.8 Emergency stop

To stop the machine in an emergency, press the EMERGENCY button (1) (Fig. 3.1 Controls on page 15) :

- The machine stops.
- The mushroom-head button will remain blocked.

5.9 Starting the machine again after a manual emergency stop

1. Eliminate the cause of the emergency stop.
2. Release the EMERGENCY button **1** (Fig. 3.1 Controls on page 15).
3. The machine is now ready to be used again.

5.10 Switching off the machine

To switch the machine off:

1. Turn the knife-switch situated upstream from the outside power supply cable to position "O".

NOTE Always clean the machine and the working area at the end of the working cycle.



PLATON SERVICE
8 (800) 500-34-41
www.platonservice.com

Chapter 6 Maintenance

DANGER Risk of electric shock and unexpected movements during maintenance.

Isolate the machine from electric and hydraulic power sources.

Dissipate and/or limit residual energy (see *Chapter 5 Machine operation*).

6.1 Routine maintenance

Any operation that can be carried out by the user is considered routine maintenance. It includes operations of cleaning, inspection and prevention carried out to ensure safe operation of the machine.

NOTE In the event that the machine vibrates, the scrapers must be carefully checked to ensure that they have not become bent at a different angle. In the event that this should happen then the scrapers should be manually bent back to their original shape.

Qualifications of operator

To carry routine maintenance safely, the user should first read carefully and understand the instructions and recommendations given in this section.

Pulizia

DANGER Cleaning operations should only be carried out with the machine switched off and disconnected from the electric and hydraulic power supplies.

Regular cleaning of your machine will ensure its good working order. We recommend the following:

- Clean the machine at the end of each shift.
- The cleaning of the machine keeps the most delicate parts in good working order and helps to spot any loosening of parts and any abnormal wear and tear.

NOTE The machine is equipped with a drawer (1), which is situated beneath the conveyor belts and allows any waste material which has been scraped to be collected. This drawer is fixed in place with a knob (2). By unscrewing the knob it is possible to clean the drawer. (Fig. 6.1 Drawer for collecting waste. on page 26)

Fig. 6.1 Drawer for collecting waste.

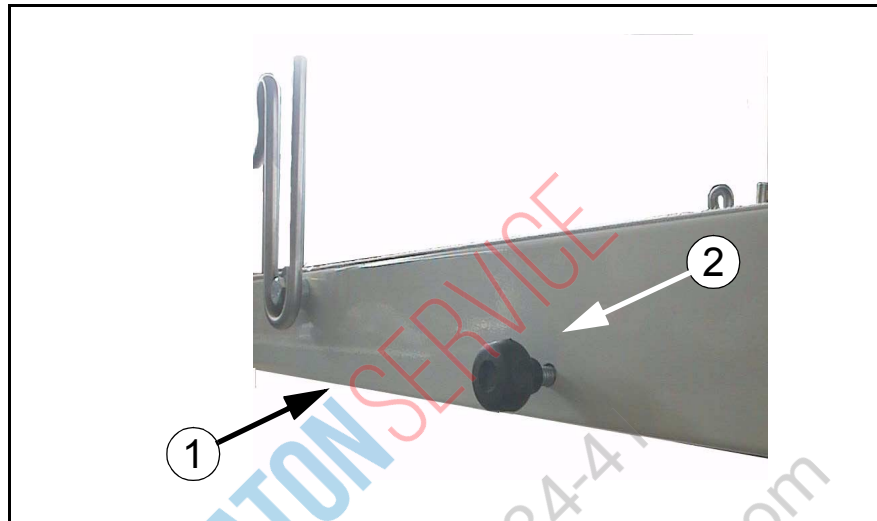

BEWARE Do not use jets of water to clean the control panels and the electric control box.

Suitable cleaning tools and products

Cleaning method

BEWARE Do not use solvents which could damage the paint and the synthetic materials. Avoid especially petrol, nitro-perchlorate thinners and trichloroethane.

Parts to be cleaned	Method and tools
Painted steel	Use warm water and food-friendly degreaser. Dry with a clean cloth.
Control panels	Clean with a soft dry cloth.
Electrical parts	Clean using a vacuum cleaner.

Frequency of cleaning

Frequency	Parts to be cleaned
Weekly	Control panels
Monthly	Motors
Monthly	Electrical components
Monthly	Steel structural work parts

6.2 Scheduled servicing

Any operation which can only be carried out by authorised personnel is considered scheduled servicing. It includes regular and preventative inspections and machine interventions carried out to ensure safe operation of the machine.

Qualifications of operator

Scheduled servicing can only be carried out safely by trained and qualified personnel who know how to operate, set-up and service the machine and who have carefully read and understood the instructions and recommendations given in this section.

Regular inspections

Regular checks and adjustments

Name of parts to be checked and adjusted	Frequency	Method
Emergency stop button	Every 40 working hours	Check the correct operation

Chapter 7 Machine scrapping

7.1 Qualifications of operator

Qualified mechanic who has read and understood *Fig. 1.1 Overall view of machine and Chapter 7 Machine scrapping*.

7.2 Disconnecting the machine

At the end of its technical and working life the machine has to be disconnected. Even though de-commissioning has taken place and the machine is no longer suited to the purpose for which it has been designed and built, it must still be possible to re-cycle the raw materials from which the machine was built.

NOTE The manufacturer will not be liable for any damage or injury to persons, animals or things caused by the re-use of individual parts of the machine for operations or assemblies other than those for which they were originally designed.

7.3 Disconnection procedure

DANGER The machine disconnecting and scrapping operations must only be carried out by trained and appropriately equipped personnel.

1. Switch off the machine, as described in *5.10 Switching off the machine* on page 24.
2. Disconnect all the power supplies. The power connections and the instructions for carrying out the operation are the same as described in *Chapter 4 Installation*.
 - a. Electric power supply. Disconnect the power supply cable from the terminal board of the electric control box.
3. Remove the following parts:
 - a. Electrical and electronic components.
 - b. Non-metallic parts and components.
4. If the machine is moved to another location, refer to *4.3 Transport* on page 17.

7.4 Residual risks after machine disconnection

Provided the instructions given in 7.2 *Disconnecting the machine* on page 28, have been followed carefully, there are no residual risks after the machine has been disconnected.

BEWARE The materials used for building the machine are non-biodegradable. The machine must therefore be taken to an authorised scrap yard for disposal.



PLATON SERVICE

8 (800) 500-34-47

www.platonservice.com

Chapter 8 **Attached documentation**



ELETRICAL SPARE PARTS 230 V mono-phase

Ref	Description
	ELECTRONIC CARD
TC1	TRANSFORMER
QSI	MAIN SWITCH
FU1	UNIPOLAR FUSE CARRIER
	FUSES
FU2	UNIPOLAR FUSE CARRIER
	FUSES
FU3	FUSE CARRIER
	FUSES
KA1	RELAY 2x U 24Vac
	BASE
KMI-2	CONTACTOR
	MECHANICAL LOCK
	AUXILIARY CONTACT
SB1	EMERGENCY PUSH BUTTON
	CONTACT
SB2	STOP BUTTON
	CONTACT
SB3	START PUSH BUTTON
	CONTACT
SC1-2	LIMIT SWITCH
	CABLE PRESS
SQ3-4	LIMIT SWITCH

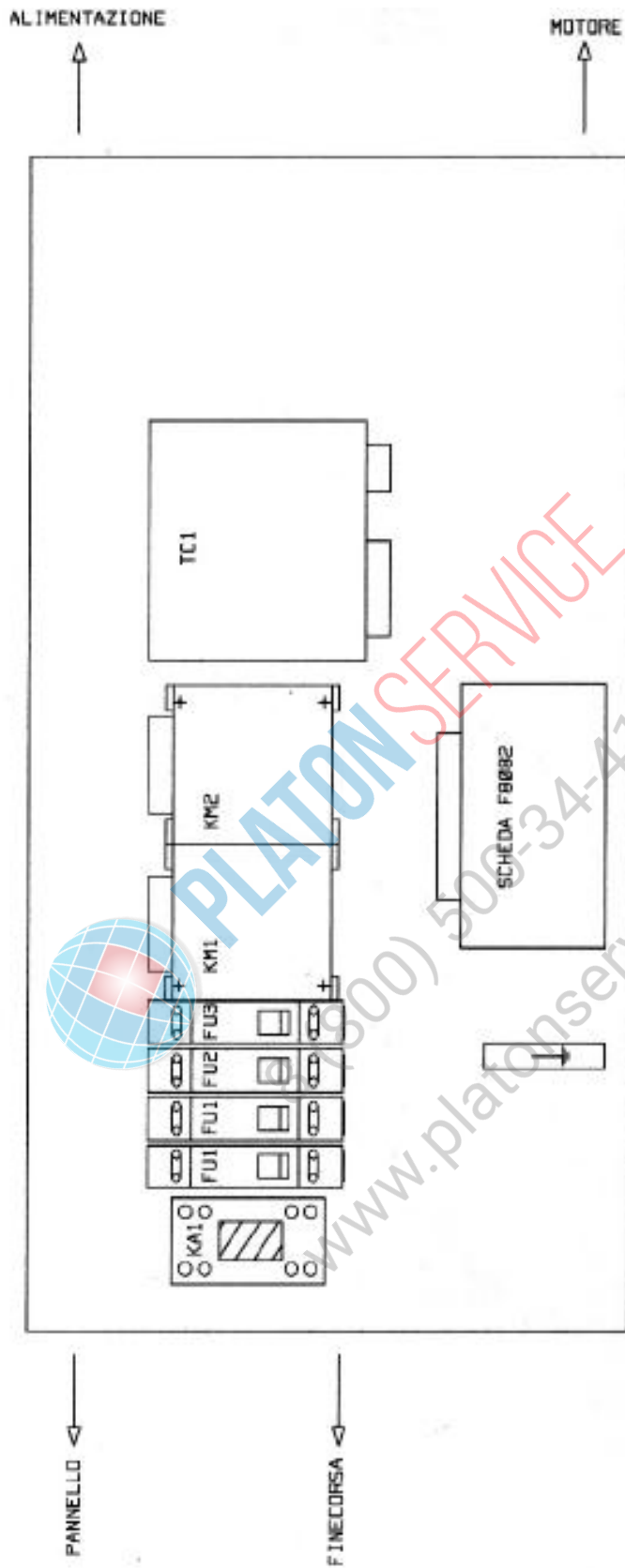

FINECORSA COMANDO 28CM. DA BORDO LAMIERA
 FINECORSA RIPARI 35CM. DA BORDO LAMIERA
 FILI GENERALE 60CM.
 CAVO ALIMENTAZIONE 3X1.5 mmq 4.60 MT.
 CAVO MOTORE 5X1.5 mmq 90 CM.
 N.1 PRESSACAVO 3/8 OTTONE

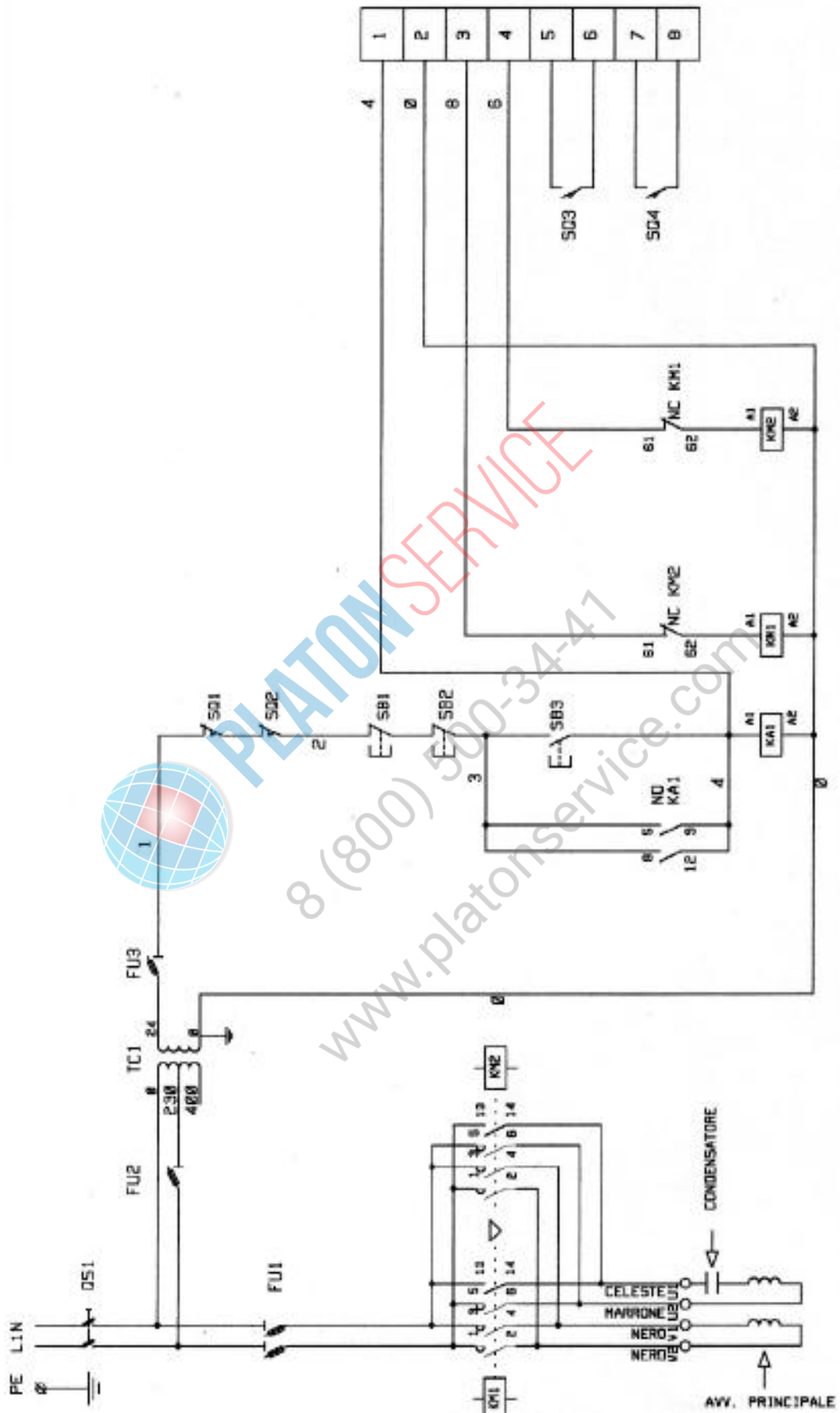

ELETRICAL SPARE PARTS 380 V three-phase

<i>Ref</i>	<i>Description</i>
QS1	MAIN SWITCH
	PRINTED CIRCUIT BOARD
TC1	TRANSFORMER
	SPACERS
FU1	FUSE CARRIER CLIP
	FUSES
	PROTECTION COVER
FU2	FUSE CARRIER CLIP
	FUSES
	PROTECTION COVER
FU3	VERTICAL FUSE CARRIER
	FUSE
KM1/2	CONTACTOR C.S.
KA1	MINI RELAY DA C.S.
	CLAMPS
	CLAMPS
	CLAMPS
	CLAMPS
	ASSEMBLY
SB1	EMERGENCY PUSH BUTTON
SB3	STOP BUTTON
SB2	START UP PUSH BUTTON
SQ1	PROTECTION LIMIT SWITCH
	CABLE PRESS
SQ2	PROTECTION LIMIT SWITCH
	CABLE PRESS
SQ3	MANUAL LIMIT SWITCH
SQ4	MANUAL LIMIT SWITCH

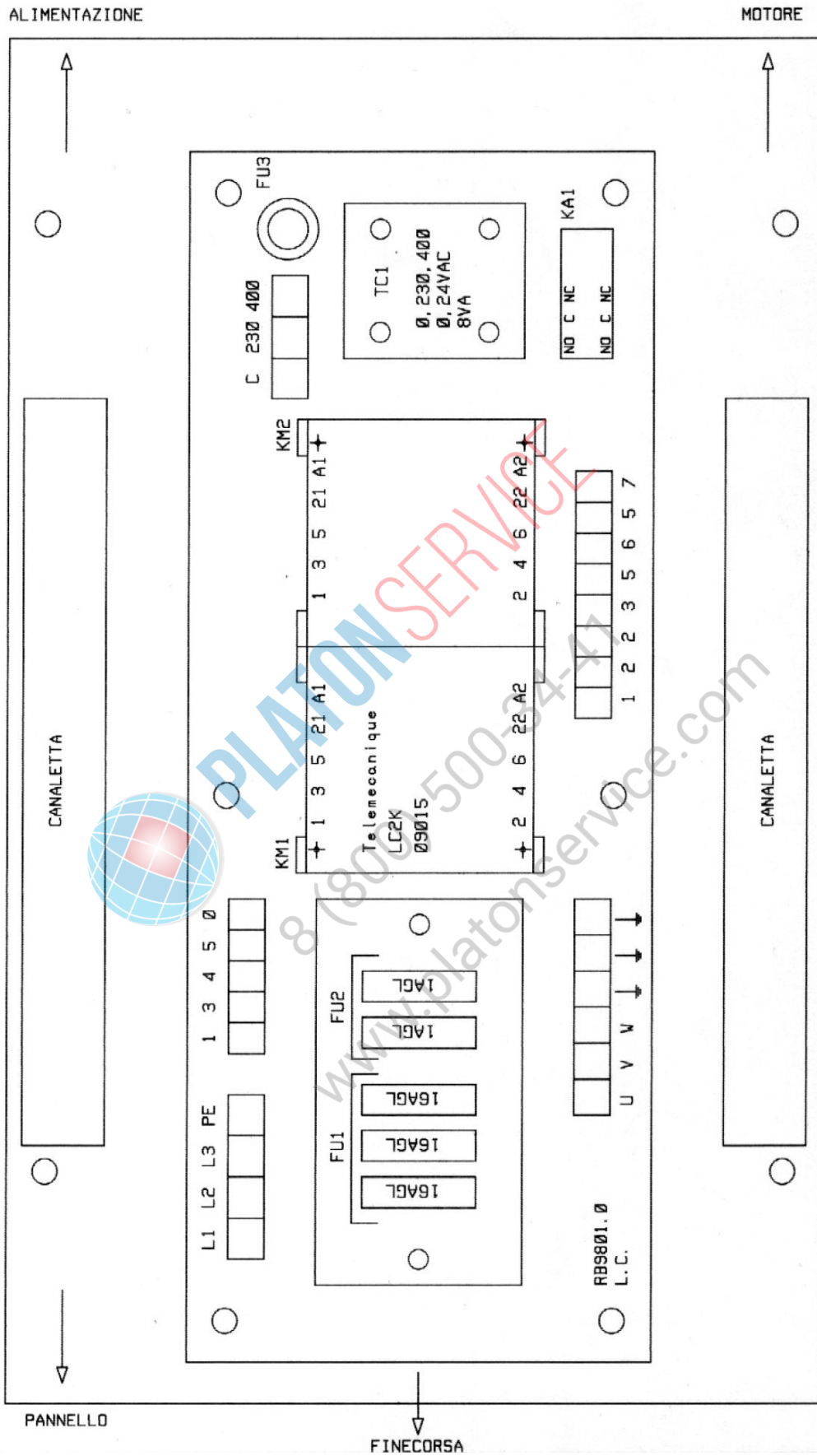

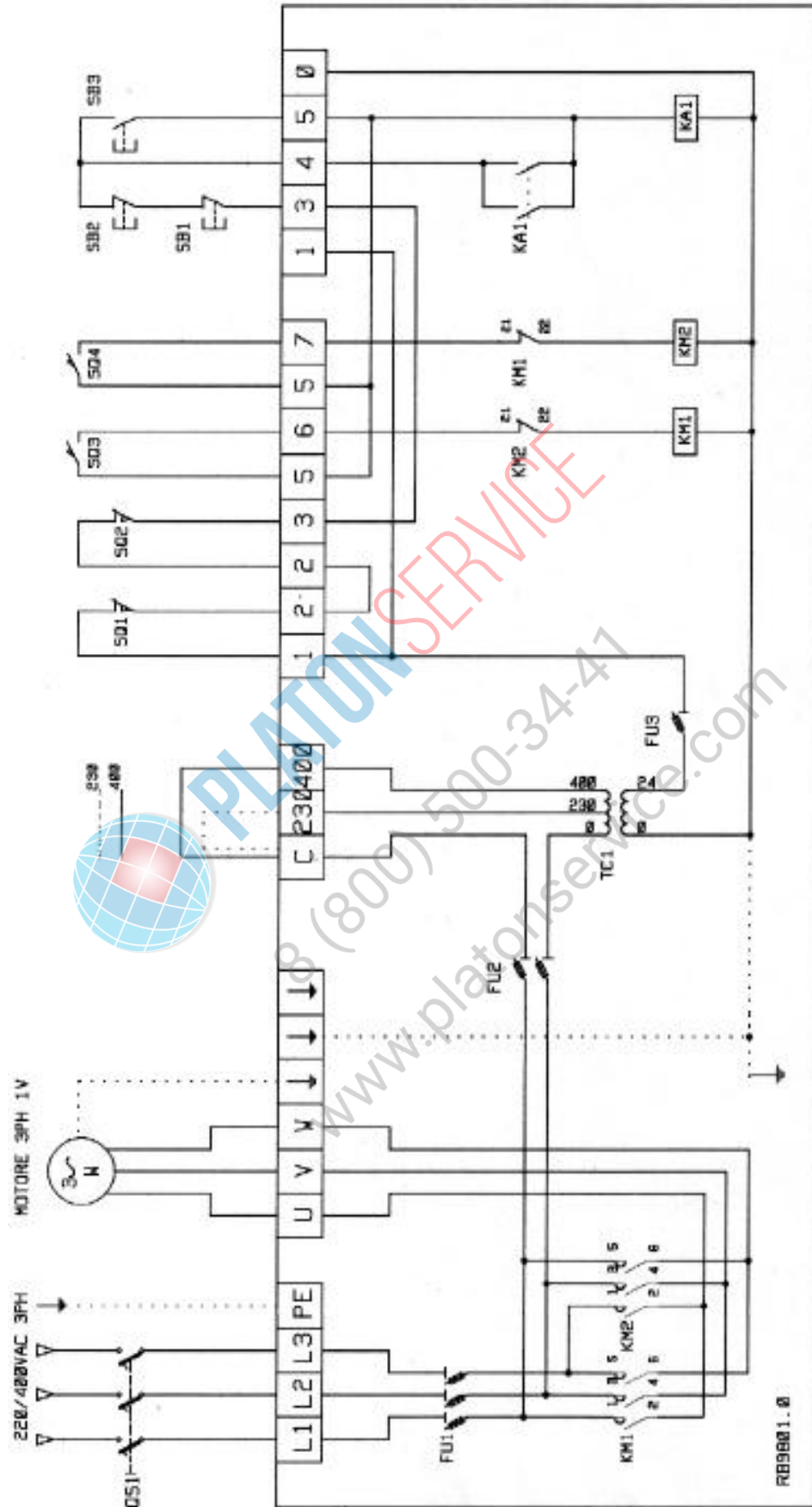
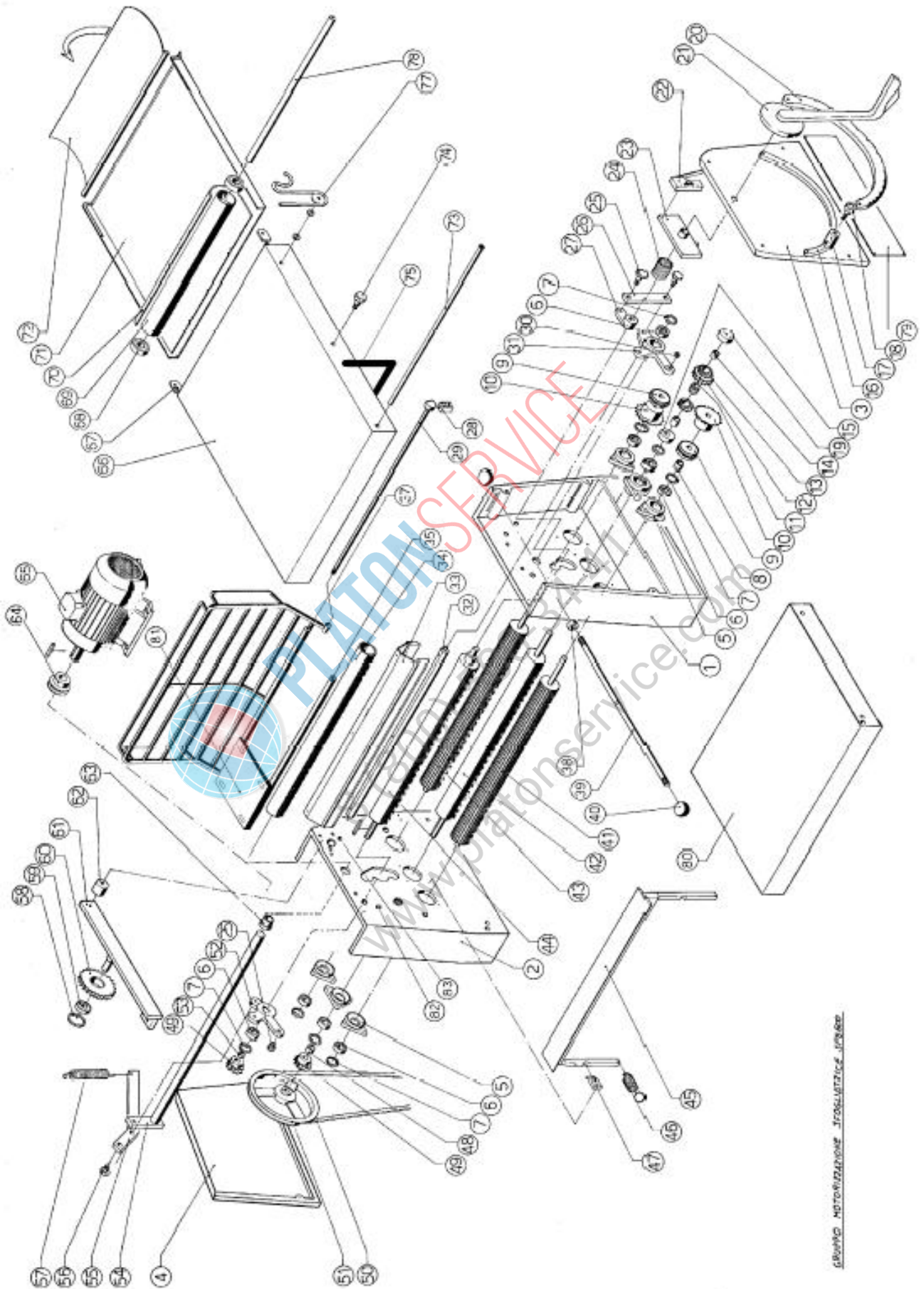

DIAGRAM 2 HEAD ASSEMBLY

1)	Right Hand Frame	43)	R.H. Belt Drive Cylinder
2)	Left Hand Frame	44)	Mobile Cylinder
3)	Right Hand Panel	45)	Lower scraper
4)	Left Hand Panel	46)	Lower scraper tension spring
5)	Flange	47)	Scraper location sector
6)	Bearing 6004 2RS	48)	Spacer
7)	'Seeger' Ring	49)	Pinion Z=16 3/8 "
8)	Spacer	50)	A49, V Belt
9)	Freewheel	51)	Pulley
10)	Threaded Pinion	52)	L.H. Connecting rod
11)	Double screw	53)	Spacer
12)	Double crown Z=16 1/8" x 1/8"	54)	Lifting shaft
13)	Double crown Z = 16 3/8"	55)	Connecting rod movement rod
14)	Spacer	56)	Bolt
15)	Spacer	57)	Handle spring
16)	Limit switch sector Lever	58)	Seeger ring
17)	Limit switch Lever	59)	Bearing 6005 2RS
18)	Handwheel	60)	Chain tightening crown
19)	Washer	61)	Chain rod
20)	Toothed sector	62)	Chain spacer and rod
21)	Handle	63)	Lifting shaft bushing
22)	Manual movement reverse microswitch	64)	Motor pulley
23)	Microswitch plate	65)	Motor
24)	Spring	66)	Table
25)	Bushing for connecting rod	67)	Belt rod
26)	Guard lifting shaft	68)	Bearing 6001 2RS
27)	Cylinder movement lever	69)	Belt stretching cylinder
28)	Grid closing microswitch	70)	Conveyor belt
29)	Grid Rod	71)	Undertable
30)	Bushing	72)	Undertable Extension Piece
31)	Right hand connecting rod	73)	Table Fulcrum Rod
32)	Upper scraper shaft holder	74)	Undertable locking handwheel
33)	Upper scraper	75)	Table support
34)	Lifting shaft protection		
35)	Spacer	77)	Rolling Pin Hook
		78)	Belt stretching shaft
37)	Protection Grid	79)	Electric Wiring panel
38)	Microswitch Spacer	80)	Base
39)	Manual movement reverse control rod	81)	Motor support
40)	Manual control knob	82)	Grid lock
41)	L.H. Belt drive cylinder	83)	Grid lock
42)	Fixed cylinder		



GRUPPO MOTORIZAZIONE INSOLITIZIA UNISE



DICHIARAZIONE DI CONFORMITÀ
DECLARATION OF CONFORMITY
DECLARACIÓN DE CONFORMIDAD
DÉCLARATION DE CONFORMITÉ
KONFORMITÄTSEKTLÄRUNG



Noi

*We / El que suscribe /
Nous / Wir*

Dr. ZANOLLI s.r.l.

Via Casa Quindici, 22

37066 Caselle di Sommacampagna, VR

dichiaro sotto la nostra esclusiva responsabilità che l'apparecchiatura
*declare under our responsibility that the equipment / declara bajo su propia responsabilidad que l'equipo /
déclarons sous notre responsabilité que l'appareil / erklären in alleiniger Verantwortung, daß das Gerät*

Marca

Manufactured by / Marca / Marque de fabrication / Bezeichnung

Modello

Model / Modelo / Model / Modell

N° di serie

Serial number / N° de serie / N° de série / Seriennummer

Anno di costruzione

Year of construction / Año de construcción / Année de construction / Baujahr

come descritto nella documentazione allegata, è in conformità con le seguenti direttive europee
*is in conformity with the following European Directives / es conforme con las siguientes Directivas europeas /
est conforme aux suivantes Directives européennes / auf das sich diese Erklärung bezieht, mit den E – Normen*

- 2014/35/CE Direttiva Bassa Tensione

Low Tension Directive / Directiva Baja Tension / Directive Basse Tension / Niederspannungsrichtlinie

- 2014/30/CE Direttiva Compatibilità Elettromagnetica

*Electromagnetic Compatibility Directive / Directiva Compatibilidad Electromagnetica /
Directive Compatibilité Electromagnétique / Elektromagnetische Verträglichkeit*

- 2006/42/CE Direttiva Macchine

Machines Directive / Directiva Maquinas / Directive Machines / Maschinenrichtlinie

- 1935/2004/CE Regolamento Oggetti destinati a venire in Contatto con i Prodotti Alimentari

*Regulation for Equipment intended to come into Contact with Foodstuffs / Normativa para Equipos destinados a
entrar en Contacto con Alimentos / Réglementation Objets destinés à venir en Contact avec des Produits
Alimentaires / Gesetzliche Regelung der Gegenstände, die mit Lebensmitteln in Kontakt kommen*

- 2011/65/CE Direttiva RoHS 2 RoHS 2 Directive / Directiva RoHS 2 / Directive RoHS 2 / Richtlinie RoHS 2

e con le norme cogenti alle direttive.

*and with the compulsory regulations of the Directives / y con las normas ineludibles de las Directivas /
et aux normes inéluctables des Directives / und mit den Zwangsvorschriften der Richtlinien, übereinstimmt*

Caselle di Sommacampagna

Dr. Zanolli s.r.l.

Collaudatore

Tester / Ensayador / Testateur / Prüfer

ALL 7.2-C3 Dichiarazione di Conformità

Rev.5 del 16/10/2019

Dr. Zanolli s.r.l.

Via Casa Quindici, 22

37066 Caselle di Sommacampagna (Verona) Italy

Tel. +39 045 8581500

Fax. +39 045 8581455

www.zanolli.it - zanolli@zanolli.it

Capitale sociale € 93.600,00

Reg. Imprese N.3367

Cod. Fisc./Part. IVA 00213620230

Codice Comunitario IT 00213620230

R.E.A. VERONA N. 57706

Export M. VR005011

Codice Univoco Fatturazione 2LCMINU

1952-ITALY

Dr. Zanolli s.r.l.
Via Casa Quindici, 22
37066 Caselle di Sommacampagna VR
Tel. +39-0458581500 Fax +39-0458581455
VAT N.IT00213620230



PLATONSERVICE
8 (800) 500000
www.platonservice.com